



ARTIST SERIES™



Thank you for purchasing this product. Before using the product, read through the user manual to ensure that you will use the product correctly. Please keep this manual for future reference.

Features

- Excels in venues with controlled stage volume or in-ear monitoring
- Condenser design for studio-quality performance
- Customised vocal reproduction, high fidelity and extreme clarity maximizing impact and intelligibility
- Cardioid polar pattern reduces pickup of sounds from the sides and rear, improving isolation of desired sound source
- Multi-stage grille design offers excellent protection against plosives and sibilance without compromising high-frequency clarity

Notes on use

- Do not directly touch or scratch the contact surface.
- When installing/removing the product, be sure to turn the power off the transmitter.
- When installing the product, do not forcibly install the product with strong force. The product may be damaged.

Safety precaution

Although this product was designed to be used safely, failing to use it correctly may result in an accident. To ensure safety, observe all warnings and cautions while using the product.

Cautions for the product

- Do not subject the product to strong impact to avoid malfunction.
- Do not disassemble, modify or attempt to repair the product.
- Do not handle the product with wet hands to avoid electric shock or injury.
- Do not store the product under direct sunlight, near heating devices or in a hot, humid or dusty place.

Installing/removing the product

How to install

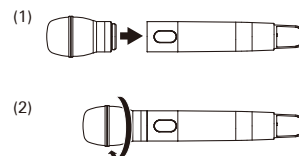

How to install

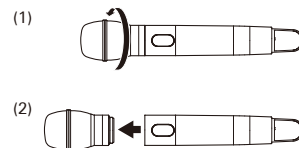

Specifications

Element	Fixed-charge back plate permanently polarized condenser
Polar pattern	Cardioid
Frequency Response	40 - 20,000 Hz *
Open Circuit Sensitivity	-40 dB (10.0 mV) re 1V at 1 Pa *
Maximum Input Sound Level	148 dB SPL, 1 kHz at 1% T.H.D. *
Weight	114 g

* Performance varies with a transmitter connected

For product improvement, the product is subject to modification without notice.

Polar pattern

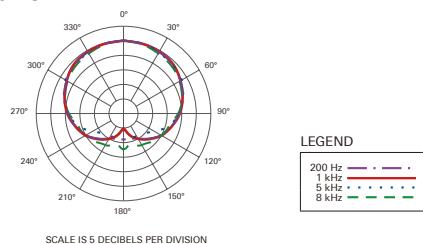

Dimensions

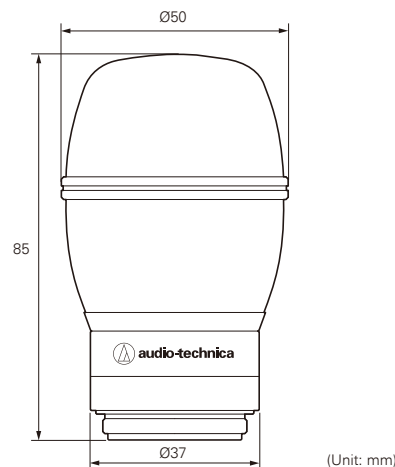



ARTIST SERIES™



感谢您购买本产品。在使用产品之前，请全文浏览本用户手册以确保您将正确地使用本产品。请妥善保存本手册，以供将来参考。

产品特点

- 擅长在舞台上音量控制或耳机监听的应用
- 专业录音质量的电容收音头设计
- 为高要求及高保真的人声语音收音而开发，提供最清晰及卓越的表现
- 心形指向性收音，能有效减低旁边及后方的杂声干扰
- 多层音头保护网结构，能加强收录爆破声时的保护，又不会影响高音的收音质量

使用注意事项

- 请勿直接触摸或划伤产品的信号接触面
- 在安装或移除产品时，务必确保将发射器的电源关闭
- 在安装产品时，请勿使用过大力量强行安装，否则可能会损坏产品

安全预防措施

虽然本产品采用安全设计，但使用不当仍可能发生事故。为了确保安全，使用本产品时请注意全部警告和提醒。

本产品注意事项

- 切勿让本产品遭受强烈冲击，以避免发生故障。
- 切勿拆开、改装或尝试维修本产品。
- 切勿用湿手握持本产品，以免触电或受伤。
- 切勿将本产品存放在阳光直射的地方、加热装置附近或者炎热、潮湿或多尘的地方。

安装/移除产品

安装方式

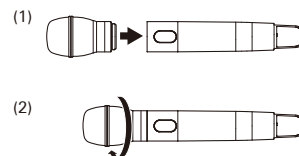

移除方式

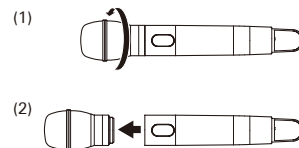

规格

元件	固定充电背板，静电型电容式
指向性	心形指向性
频率响应	40~20,000 Hz *
开路灵敏度	-40 dB (10.0 mV) 以 1V 于 1 Pa *
输入声压级上限	148 dB 声压, 1 kHz 于 1% T.H.D. *
重量	114 克

* 性能会因应连接的发射机而改变。

因产品改进，本产品会随时改装，恕不另行通知。

指向性

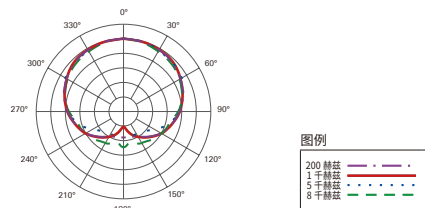

比例是每分隔线 5 分贝

尺寸

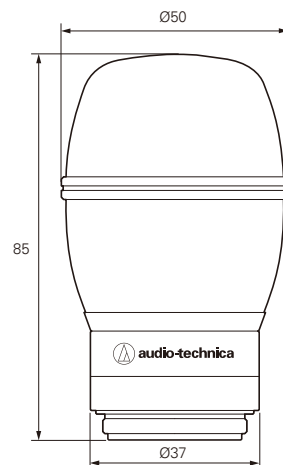

(单位: mm)